

B

B

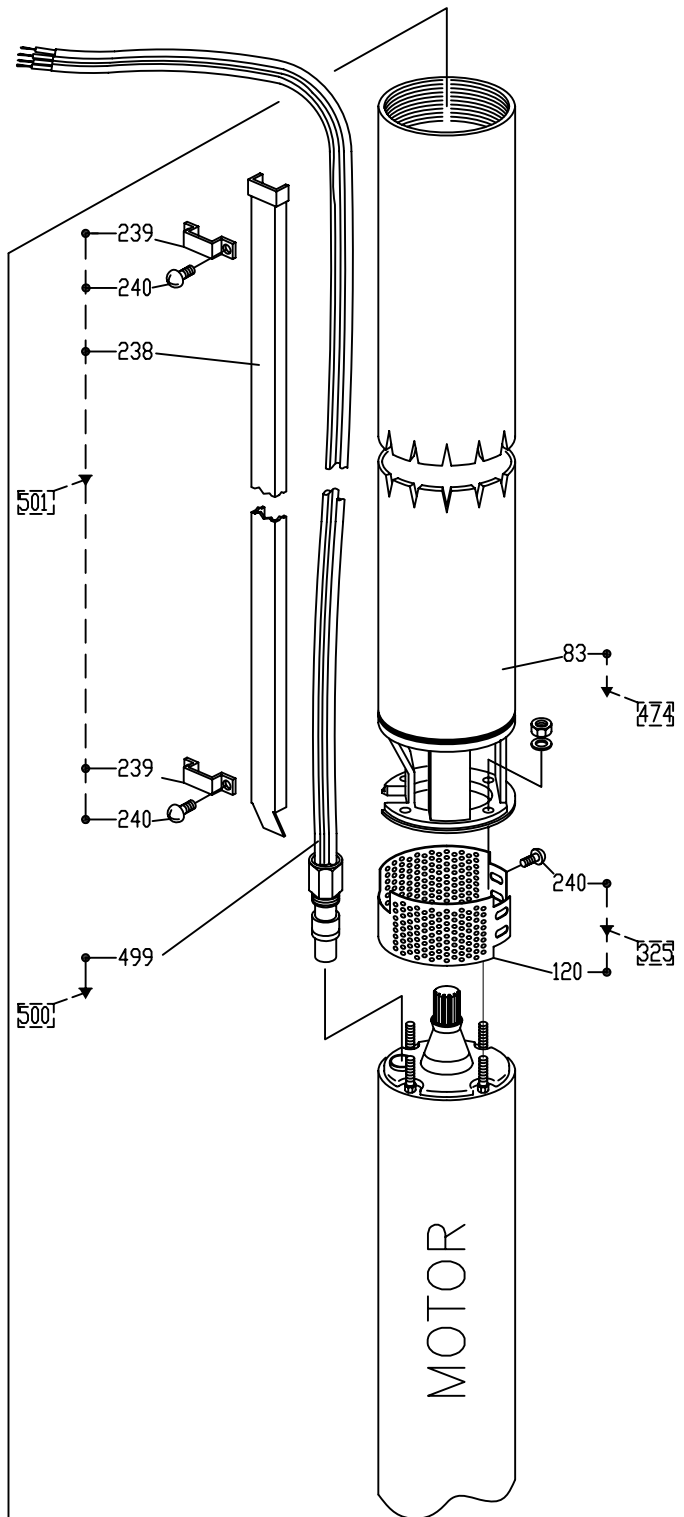

A

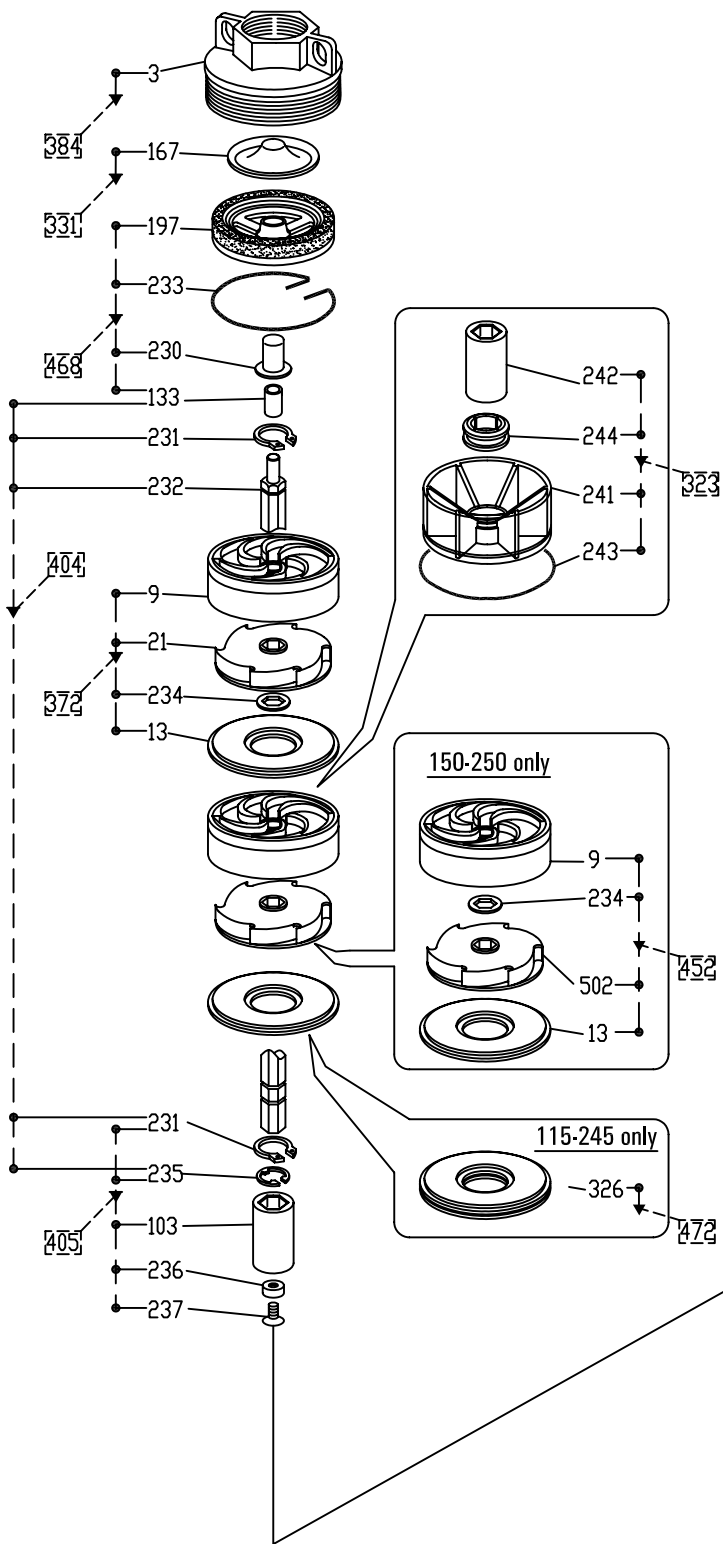

Pentair Water Italy S.r.l.
Via Masaccio,13
56010 Lugnano (PI)
ITALY

Drawn A.Bertola
Approved M.Bernacca

Title SCM 4" PLUS
Date (dd/mm/yy) 04-02-2010
Dwg #

Sheet 1 of 2

DR100001_01

This drawing is the absolute property of Pentair Water Italy S.r.l. It may not be reproduced in any form without the written permission of Pentair Water Italy S.r.l.

SCM4"Plus 40lt serie

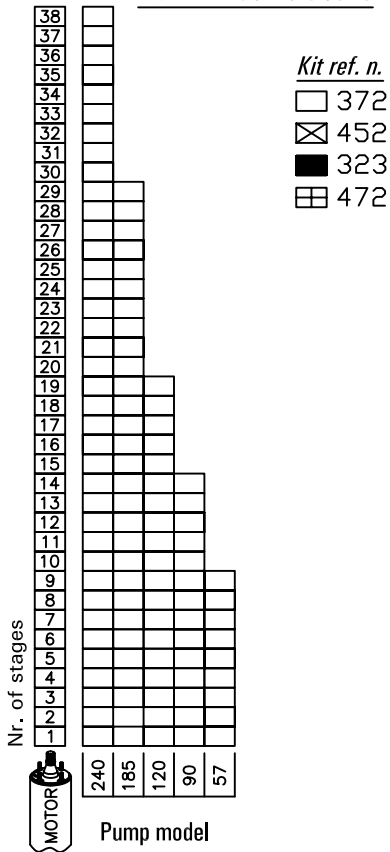

SCM4"Plus 55lt serie

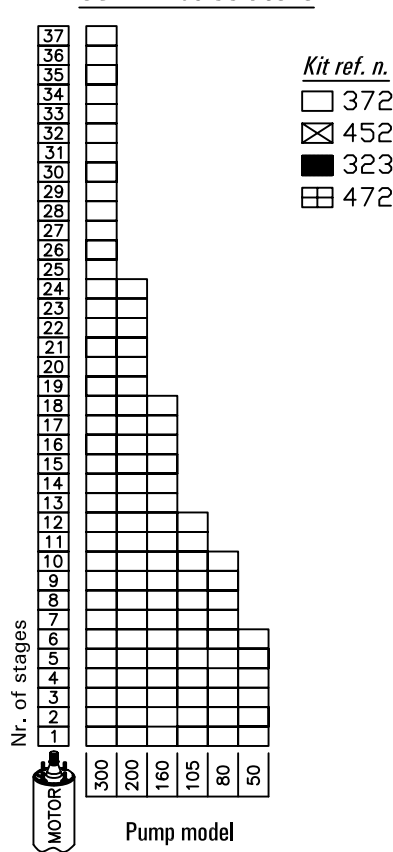

SCM4"Plus 75lt serie

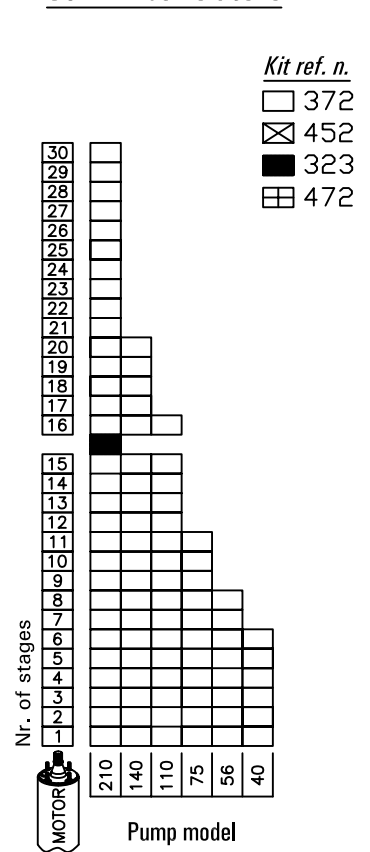

SCM4"Plus 115lt serie

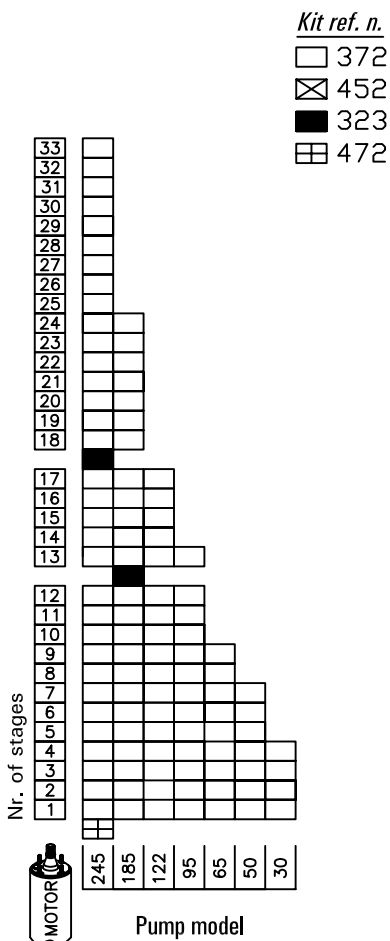

SCM4"Plus 150lt serie

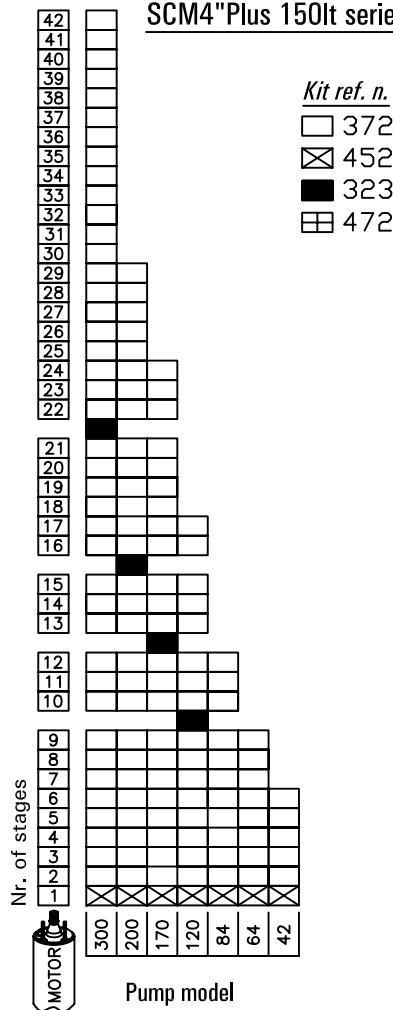

SCM4"Plus 250lt serie

